









DE	<b>FOLDZILLA Montageanleitung Tipi</b>		Achtung! Nicht für Kinder unter 3 Jahren geeignet. Kleinteile können abgerissen und verschluckt werden. Erstickungsgefahr.
IT	<b>FOLDZILLA Istruzioni di montaggio Tenda Teepee</b>		Attenzione! Prodotto non adatto a bambini di età inferiore ai 3 anni. Le piccole parti possono essere strappate e inghiottite. Pericolo di soffocamento
EN	<b>FOLDZILLA Assembly instructions Tepee</b>		Warning! Not suitable for children under the age of 3. Small parts can be ripped off and swallowed. Choking hazard.
ES	<b>FOLDZILLA Instrucciones de montaje Tipi</b>		¡Atención! No apta para niños menores de 3 años. Pueden desprenderse piezas pequeñas y tragarse. Peligro de asfixia.
FR	<b>FOLDZILLA Instructions de montage Tipi</b>		Attention ! Ne convient pas aux enfants de moins de 3 ans. Contient des petits éléments qui peuvent être arrachés et avalés. Risque d'étouffement.
PL	<b>FOLDZILLA Instrukcja montażu Tipi</b>		Uwaga!!! Nie nadaje się dla dzieci poniżej 3 roku życia. Małe części mogą się oderwać i zostać połknięte. Niebezpieczeństwo zadławienia.
NL/BE	<b>FOLDZILLA Montagehandleiding Tipi</b>		Attentie! Niet voor kinderen onder 3 jaar geschikt. Kleine delen kunnen afgescheurd en ingeslikt worden. Verstikkingsgevaar.

1

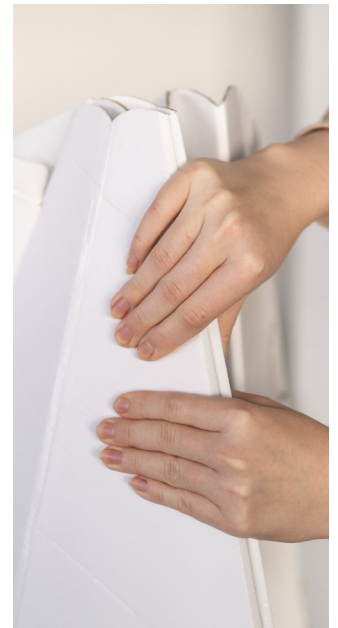
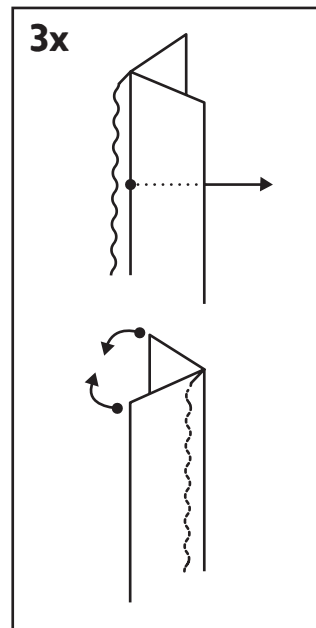
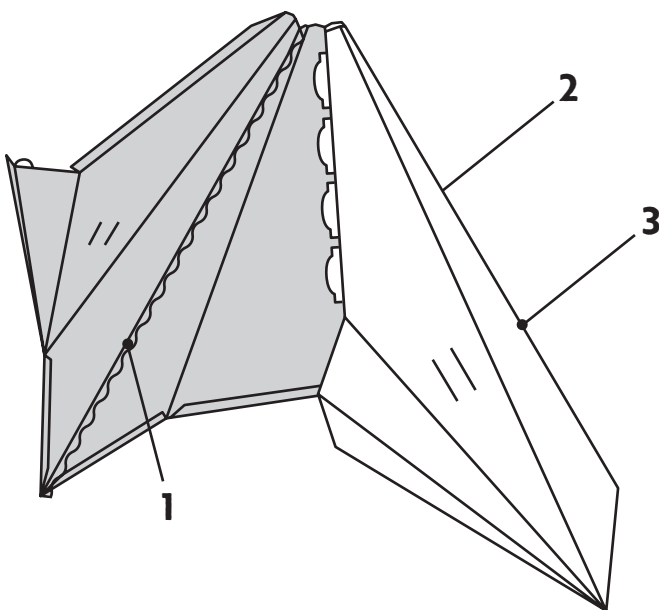
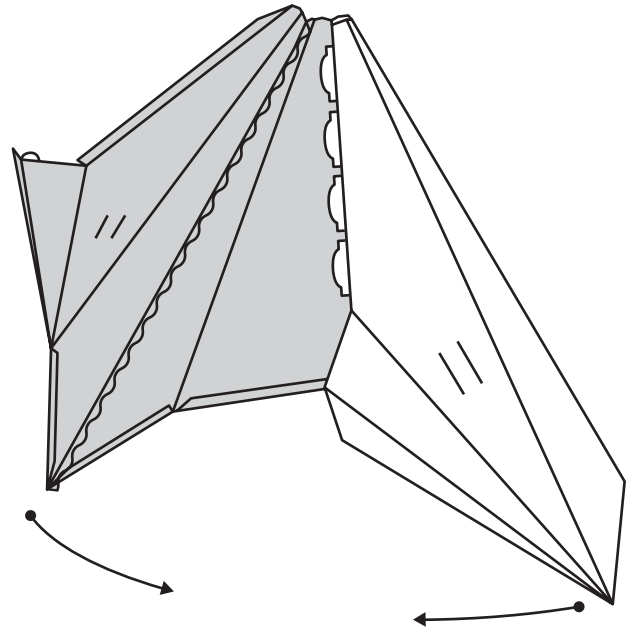
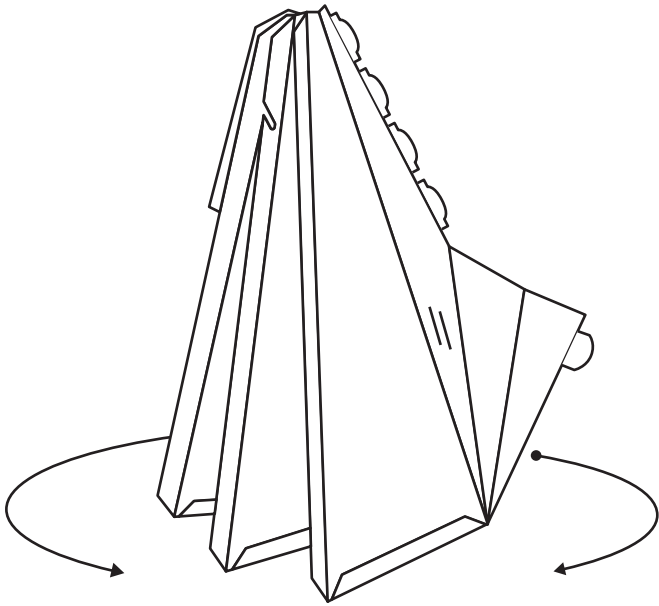

2

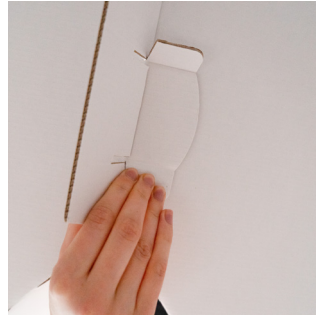
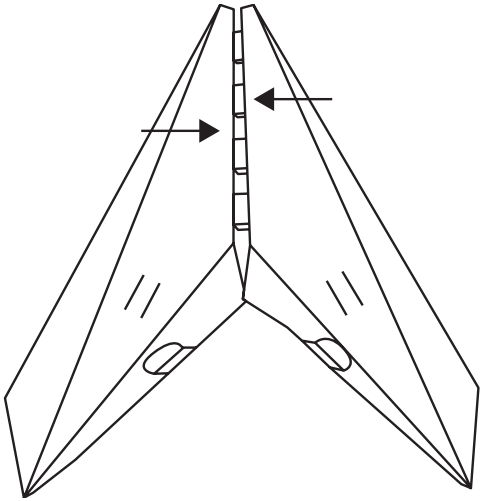

3

